

**N - CHANNEL ENHANCEMENT MODE
POWER MOS TRANSISTORS**

TYPE	V _{DSS}	R _{DS(on)}	I _D
IRF830	500 V	< 1.5 Ω	4.5 A
IRF830FI	500 V	< 1.5 Ω	3 A
IRF831	450 V	< 1.5 Ω	4.5 A
IRF831FI	450 V	< 1.5 Ω	3 A

- TYPICAL R_{DS(on)} = 1.35 Ω
- AVALANCHE RUGGED TECHNOLOGY
- 100% AVALANCHE TESTED
- REPETITIVE AVALANCHE DATA AT 100°C

APPLICATIONS

- HIGH CURRENT, HIGH SPEED SWITCHING
- SWITCH MODE POWER SUPPLIES (SMPS)
- CHOPPER REGULATORS, CONVERTERS, MOTOR CONTROL, LIGHTING FOR INDUSTRIAL AND CONSUMER ENVIRONMENT

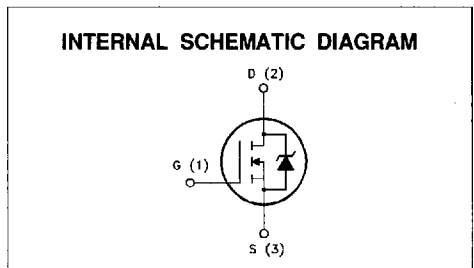
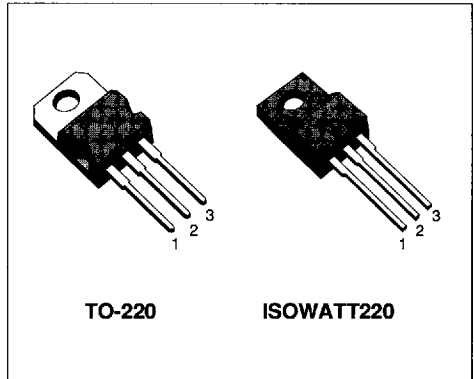

ABSOLUTE MAXIMUM RATINGS

Symbol	Parameter	Value				Unit
		IRF				
		830	831	830FI	831FI	
V _{DS}	Drain-source Voltage (V _{GS} = 0)	500	450	500	450	V
V _{DGR}	Drain- gate Voltage (R _{GS} = 20 kΩ)	500	450	500	450	V
V _{GS}	Gate-source Voltage	± 20				V
I _D	Drain Current (cont.) at T _c = 25 °C	4.5	4.5	3	3	A
I _D	Drain Current (cont.) at T _c = 100 °C	3	3	1.8	1.8	A
I _{DM} (*)	Drain Current (pulsed)	15	15	15	15	A
P _{tot}	Total Dissipation at T _c = 25 °C	100		35		W
	Derating Factor	0.8		0.28		W/°C
V _{ISO}	Insulation Withstand Voltage (DC)	—		2000		V
T _{stg}	Storage Temperature	-65 to 150				°C
T _j	Max. Operating Junction Temperature	150				°C

(*) Pulse width limited by safe operating area

THERMAL DATA

			TO-220	ISOWATT20	
R _{thj-case}	Thermal Resistance Junction-case	Max	1.25	3.57	°C/W
R _{thj-amb}	Thermal Resistance Junction-ambient	Max		62.5	°C/W
R _{thc-s}	Thermal Resistance Case-sink	Typ		0.5	°C/W
T _l	Maximum Lead Temperature For Soldering Purpose			300	°C

AVALANCHE CHARACTERISTICS

Symbol	Parameter	Max Value	Unit
I _{AR}	Avalanche Current, Repetitive or Not-Repetitive (pulse width limited by T _j max, δ < 1%)	4.5	A
E _{AS}	Single Pulse Avalanche Energy (starting T _j = 25 °C, I _D = I _{AR} , V _{DD} = 25 V)	280	mJ
E _{AR}	Repetitive Avalanche Energy (pulse width limited by T _j max, δ < 1%)	7.4	mJ
I _{AR}	Avalanche Current, Repetitive or Not-Repetitive (T _c = 100 °C, pulse width limited by T _j max, δ < 1%)	2.5	A

ELECTRICAL CHARACTERISTICS (T_{case} = 25 °C unless otherwise specified)

OFF

Symbol	Parameter	Test Conditions	Min.	Typ.	Max.	Unit
V _{(BR)DSS}	Drain-source Breakdown Voltage	I _D = 250 μA V _{GS} = 0 for IRF830/830FI for IRF831/831FI	500 450			V V
I _{DSS}	Zero Gate Voltage Drain Current (V _{GS} = 0)	V _{DS} = Max Rating V _{DS} = Max Rating x 0.8 T _c = 125 °C			250 1000	μA μA
I _{GSS}	Gate-body Leakage Current (V _{DS} = 0)	V _{GS} = ± 20 V			± 100	nA

ON (*)

Symbol	Parameter	Test Conditions	Min.	Typ.	Max.	Unit
V _{GS(th)}	Gate Threshold Voltage	V _{DS} = V _{GS} I _D = 250 μA	2	3	4	V
R _{DS(on)}	Static Drain-source On Resistance	V _{GS} = 10V I _D = 2.5 A		1.35	1.5	Ω
I _{D(on)}	On State Drain Current	V _{DS} > I _{D(on)} x R _{DS(on)max} V _{GS} = 10 V	4.5			A

DYNAMIC

Symbol	Parameter	Test Conditions	Min.	Typ.	Max.	Unit
g _{fs} (*)	Forward Transconductance	V _{DS} > I _{D(on)} x R _{DS(on)max} I _D = 2.5 A	2.7	3.4		S
C _{iss}	Input Capacitance	V _{DS} = 25 V f = 1 MHz V _{GS} = 0		600	800	pF
C _{oss}	Output Capacitance			100	130	pF
C _{rss}	Reverse Transfer Capacitance			40	55	pF

ELECTRICAL CHARACTERISTICS (continued)

SWITCHING RESISTIVE LOAD

Symbol	Parameter	Test Conditions	Min.	Typ.	Max.	Unit
$t_{d(on)}$	Turn-on Time	$V_{DD} = 225\text{ V}$ $I_D = 2.5\text{ A}$		45	60	ns
t_r	Rise Time	$R_G = 15\ \Omega$		34	42	ns
$t_{d(off)}$	Turn-off Delay Time	(see test circuit)		125	155	ns
t_f	Fall Time			39	50	ns
Q_g	Total Gate Charge	$I_D = 4.5\text{ A}$ $V_{GS} = 10\text{ V}$		42	52	nC
Q_{gs}	Gate-Source Charge	$V_{DD} = \text{Max Rating} \times 0.8$		6		nC
Q_{gd}	Gate-Drain Charge	(see test circuit)		20		nC

SOURCE DRAIN DIODE

Symbol	Parameter	Test Conditions	Min.	Typ.	Max.	Unit
I_{SD}	Source-drain Current				4.5	A
$I_{SDM}(\bullet)$	Source-drain Current (pulsed)				15	A
$V_{SD}(\ast)$	Forward On Voltage	$I_{SD} = 4.5\text{ A}$ $V_{GS} = 0$			1.6	V
t_{rr}	Reverse Recovery Time	$I_{SD} = 4.5\text{ A}$ $di/dt = 100\text{ A}/\mu\text{s}$ $V_{DD} = 100\text{ V}$ $T_j = 150\text{ }^\circ\text{C}$		430		ns
Q_{rr}	Reverse Recovery Charge			3.8		μC

(*) Pulsed: Pulse duration = 300 μs , duty cycle 1.5 %

(\bullet) Pulse width limited by safe operating area

Safe Operating Area for TO-220

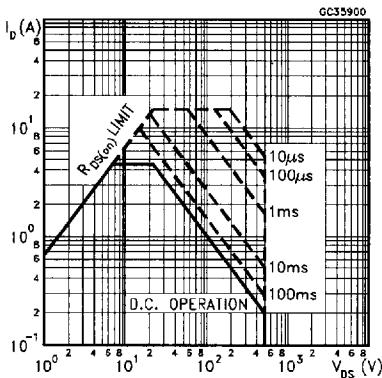

Safe Operating Area for ISOWATT220

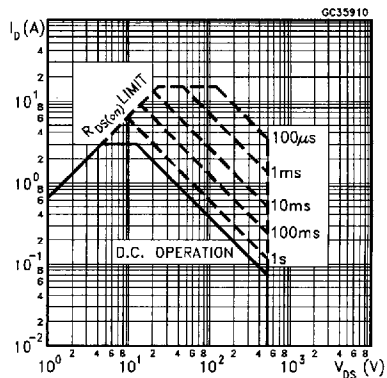

Thermal Impedance for TO-220

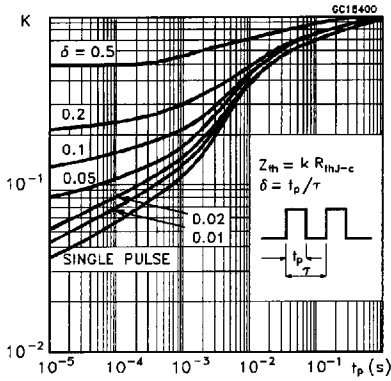

Thermal Impedance for ISOWATT220

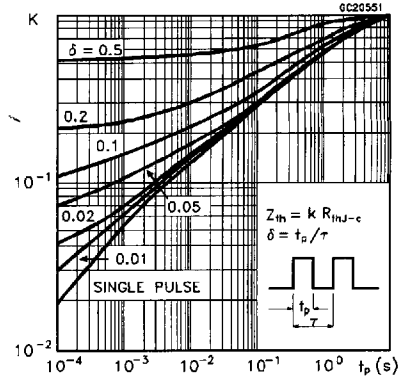

Derating Curve for TO-220

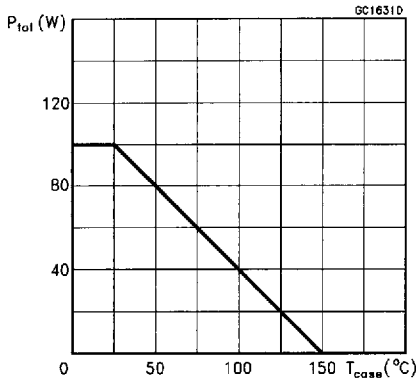

Derating Curve for ISOWATT220

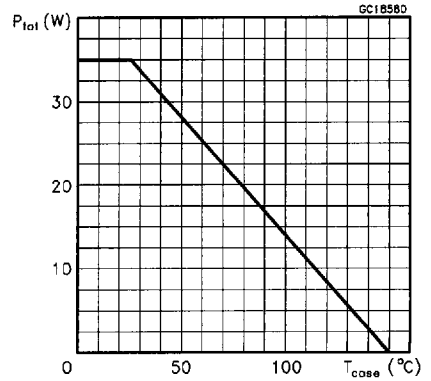

Output Characteristics

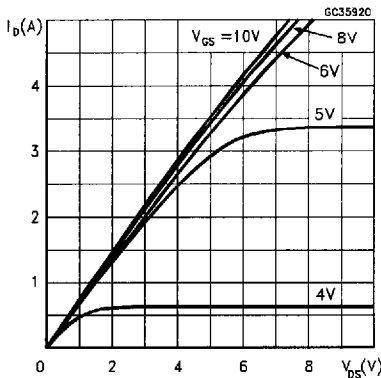

Output Characteristics

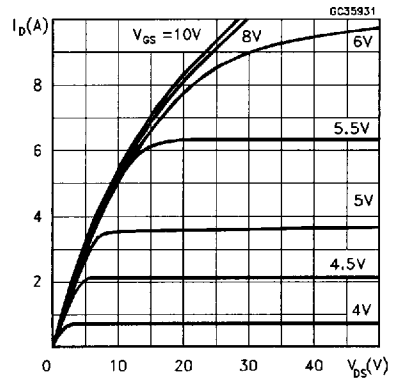

Transfer Characteristics

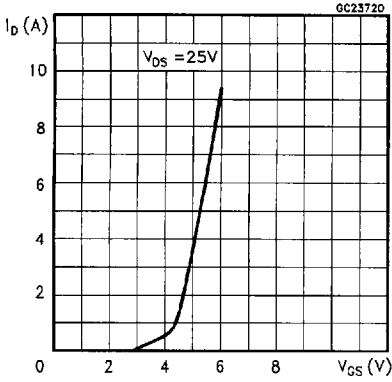

Transconductance

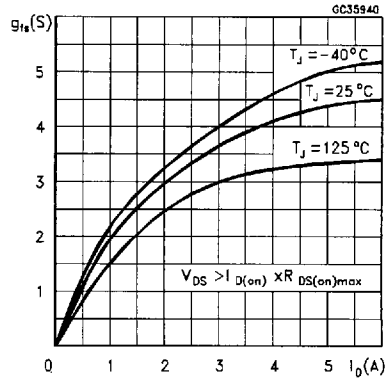

Static Drain-source On Resistance

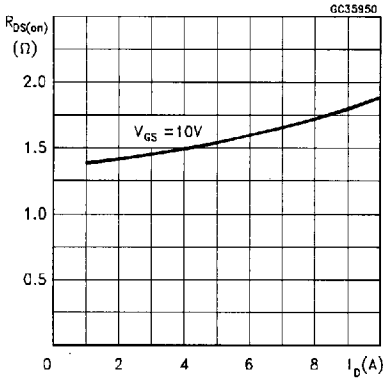

Maximum Drain Current vs Temperature

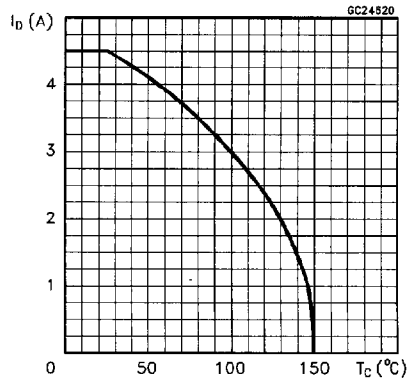

Gate Charge vs Gate-source Voltage

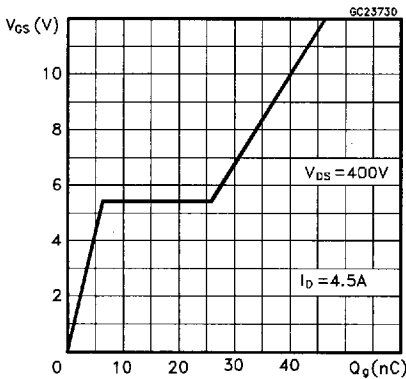

Capacitance Variations

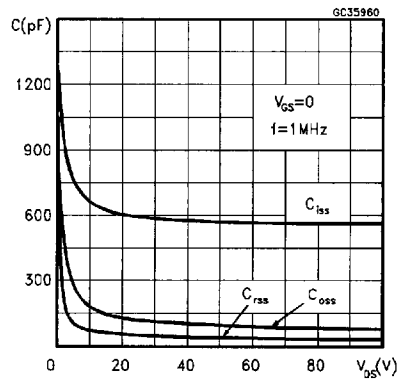

Normalized Breakdown Voltage vs Temperature

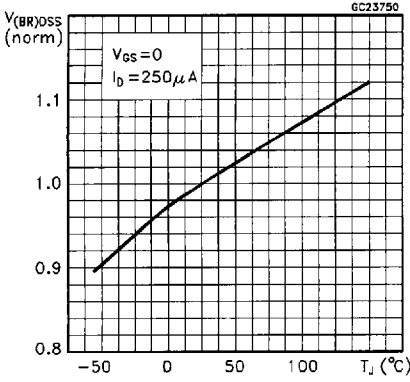

Normalized On Resistance vs Temperature

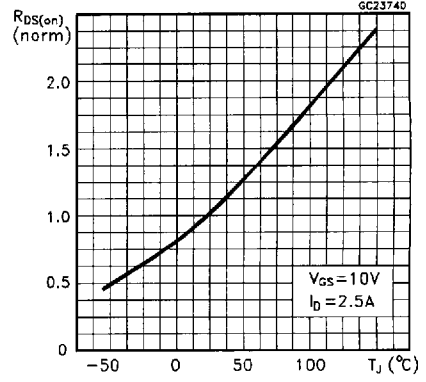

Source-drain Diode Forward Characteristics

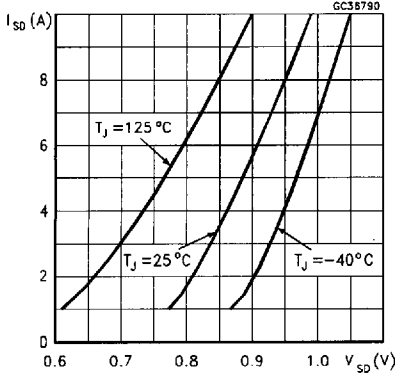

Unclamped Inductive Load Test Circuit

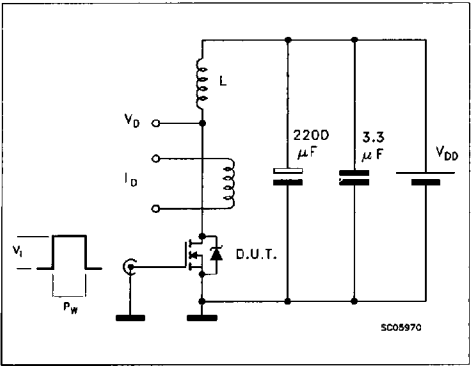

Unclamped Inductive Waveforms

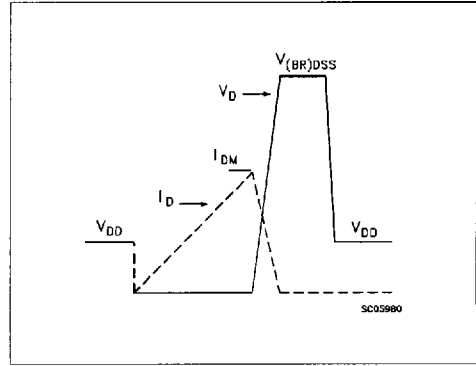

Switching Time Test Circuit

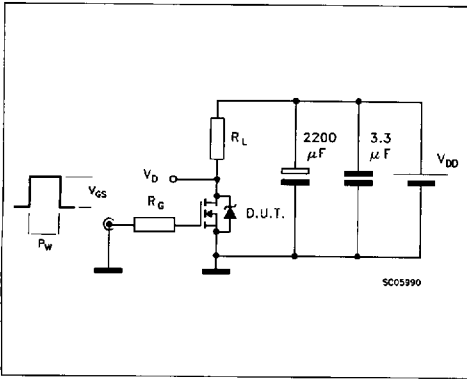

Gate Charge Test Circuit

