



# CY7C191 CY7C192

## 64K x 4 Static RAM with Separate I/O

### Features

- High speed  
— 12 ns
- Transparent write (CY7C191)
- CMOS for optimum speed/power
- Low active power  
— 880 mW
- Low standby power  
— 220 mW
- TTL-compatible inputs and outputs
- Automatic power-down when deselected

### Functional Description

The CY7C191 and CY7C192 are high-performance CMOS static RAMs organized as 65,536 x 4 bits with separate I/O. Easy memory expansion is provided by active LOW chip enable ( $\overline{CE}$ ) and three-state drivers. They have an automatic power-down feature, reducing the power consumption by 75% when deselected.

Writing to the device is accomplished when the chip enable ( $\overline{CE}$ ) and write enable ( $\overline{WE}$ ) inputs are both LOW.

Data on the four input pins ( $I_0$  through  $I_3$ ) is written into the memory location specified on the address pins ( $A_0$  through  $A_{15}$ ).

Reading the device is accomplished by taking the chip enable ( $\overline{CE}$ ) LOW while the write enable ( $\overline{WE}$ ) remains HIGH. Under these conditions the contents of the memory location specified on the address pins will appear on the four data output pins.

The output pins stay in high-impedance state when write enable ( $\overline{WE}$ ) is LOW (CY7C192 only), or chip enable ( $\overline{CE}$ ) is HIGH.

A die coat ensures alpha immunity.

2

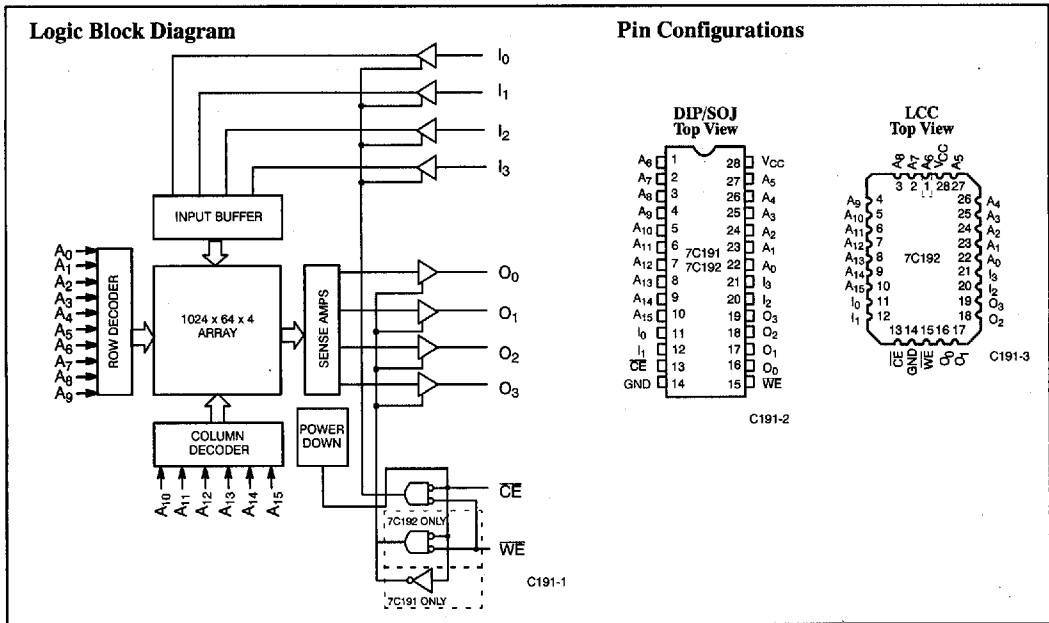

### Selection Guide

		7C191-12 7C192-12	7C191-15 7C192-15	7C191-20 7C192-20	7C191-25 7C192-25	7C191-35 7C192-35	7C191-45 7C192-45
Maximum Access Time (ns)		12	15	20	25	35	45
Maximum Operating Current (mA)	Commercial	155	145	135	115	115	
	Military		160	150	125	125	125
Maximum Standby Current (mA)		30	30	30	30	30	30

Shaded area contains advanced information.



**Maximum Ratings**

(Above which the useful life may be impaired. For user guidelines, not tested.)

- Storage Temperature ..... -65°C to +150°C
- Ambient Temperature with Power Applied ..... -55°C to +125°C
- Supply Voltage to Ground Potential (Pin 28 to Pin 14) ..... -0.5V to +7.0V
- DC Voltage Applied to Outputs in High Z State<sup>[1]</sup> ..... -0.5V to V<sub>CC</sub> + 0.5V
- DC Input Voltage<sup>[1]</sup> ..... -0.5V to V<sub>CC</sub> + 0.5V
- Output Current into Outputs (LOW) ..... 20 mA

Static Discharge Voltage ..... >2001V (per MIL-STD-883, Method 3015)

Latch-Up Current ..... >200 mA

**Operating Range**

Range	Ambient Temperature	V <sub>CC</sub>
Commercial	0°C to +70°C	5V ± 10%
Military <sup>[2]</sup>	-55°C to +125°C	5V ± 10%

**Electrical Characteristics Over the Operating Range<sup>[3]</sup>**

Parameter	Description	Test Conditions	7C191-12 7C192-12		7C191-15 7C192-15		Unit
			Min.	Max.	Min.	Max.	
V <sub>OH</sub>	Output HIGH Voltage	V <sub>CC</sub> = Min., I <sub>OH</sub> = - 4.0 mA	2.4		2.4		V
V <sub>OL</sub>	Output LOW Voltage	V <sub>CC</sub> = Min., I <sub>OL</sub> = 8.0 mA		0.4		0.4	V
V <sub>IH</sub>	Input HIGH Voltage		2.2	V <sub>CC</sub> + 0.3V	2.2	V <sub>CC</sub> + 0.3V	V
V <sub>IL</sub>	Input LOW Voltage <sup>[1]</sup>		-0.5	0.8	-0.5	0.8	V
I <sub>IX</sub>	Input Load Current	GND ≤ V <sub>I</sub> ≤ V <sub>CC</sub>	-5	+5	-5	+5	µA
I <sub>OZ</sub>	Output Leakage Current	GND ≤ V <sub>O</sub> ≤ V <sub>CC</sub> , Output Disabled	-5	+5	-5	+5	µA
I <sub>OS</sub>	Output Short Circuit Current <sup>[4]</sup>	V <sub>CC</sub> = Max., V <sub>OUT</sub> = GND		-300		-300	mA
I <sub>CC</sub>	V <sub>CC</sub> Operating Supply Current	V <sub>CC</sub> = Max., I <sub>OUT</sub> = 0 mA, f = f <sub>MAX</sub> = 1/t <sub>RC</sub>	Com'l	155		145	mA
			Mil			160	
I <sub>SB1</sub>	Automatic $\overline{CE}$ Power-Down Current—TTL Inputs	Max. V <sub>CC</sub> , $\overline{CE} \geq V_{IH}$ , V <sub>IN</sub> ≥ V <sub>IH</sub> or V <sub>IN</sub> ≤ V <sub>IL</sub> , f = f <sub>MAX</sub>		30		30	mA
I <sub>SB2</sub>	Automatic $\overline{CE}$ Power-Down Current—CMOS Inputs	Max. V <sub>CC</sub> , $\overline{CE} \geq V_{CC} - 0.3V$ , V <sub>IN</sub> ≥ V <sub>CC</sub> - 0.3V or V <sub>IN</sub> ≤ 0.3V, f = 0	Com'l	10		10	mA
			Mil			15	

Shaded area contains preliminary information.

**Notes:**

1. Minimum voltage is equal to - 2.0V for pulse durations of less than 20 ns.
2. T<sub>A</sub> is the "instant on" case temperature.
3. See the last page of this specification for Group A subgroup testing information.
4. Not more than 1 output should be shorted at one time. Duration of the short circuit should not exceed 30 seconds.

**Electrical Characteristics Over the Operating Range<sup>[3]</sup> (continued)**

Parameter	Description	Test Conditions	7C191-20 7C192-20		7C191-25, 35, 45 7C192-25, 35, 45		Unit
			Min.	Max.	Min.	Max.	
V <sub>OH</sub>	Output HIGH Voltage	V <sub>CC</sub> = Min., I <sub>OH</sub> = -4.0 mA	2.4		2.4		V
V <sub>OL</sub>	Output LOW Voltage	V <sub>CC</sub> = Min., I <sub>OL</sub> = 8.0 mA		0.4		0.4	V
V <sub>IH</sub>	Input HIGH Voltage		2.2	V <sub>CC</sub> + 0.3V	2.2	V <sub>CC</sub> + 0.3V	V
V <sub>IL</sub>	Input LOW Voltage <sup>[1]</sup>		-0.5	0.8	-3.0	0.8	V
I <sub>IX</sub>	Input Load Current	GND ≤ V <sub>I</sub> ≤ V <sub>CC</sub>	-5	+5	-5	+5	μA
I <sub>OZ</sub>	Output Leakage Current	GND ≤ V <sub>O</sub> ≤ V <sub>CC</sub> , Output Disabled	-5	+5	-5	+5	μA
I <sub>OS</sub>	Output Short Circuit Current <sup>[4]</sup>	V <sub>CC</sub> = Max., V <sub>OUT</sub> = GND		-300		-300	mA
I <sub>CC</sub>	V <sub>CC</sub> Operating Supply Current	V <sub>CC</sub> = Max., I <sub>OUT</sub> = 0 mA, f = f <sub>MAX</sub> = 1/trc	Com'l	135	115		mA
			Mil	150	125		
I <sub>SB1</sub>	Automatic CE Power-Down Current—TTL Inputs	Max. V <sub>CC</sub> , CE ≥ V <sub>IH</sub> , V <sub>IN</sub> ≥ V <sub>IH</sub> or V <sub>IN</sub> ≤ V <sub>IL</sub> , f = f <sub>MAX</sub>		30		30	mA
I <sub>SB2</sub>	Automatic CE Power-Down Current—CMOS Inputs	CE ≥ V <sub>CC</sub> - 0.3V, V <sub>IN</sub> ≤ V <sub>CC</sub> - 0.3V or V <sub>IN</sub> ≤ 0.3V, f = 0		15		15	mA

Shaded area contains advanced information.

**Capacitance<sup>[5]</sup>**

Parameter	Description	Test Conditions	Max.	Unit
C <sub>IN</sub>	Input Capacitance	T <sub>A</sub> = 25°C, f = 1 MHz, V <sub>CC</sub> = 5.0V	8	pF
C <sub>OUT</sub>	Output Capacitance		10	pF

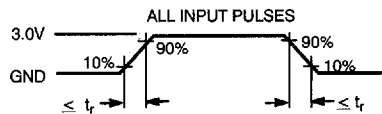
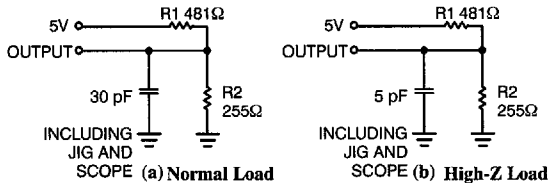
**AC Test Loads and Waveforms<sup>[6]</sup>**

C191-4

C191-5

 Equivalent to: THÉVENIN EQUIVALENT  
 167Ω  
 OUTPUT ○ ———— 1.73V

**Notes:**

- Tested initially and after any design or process changes that may affect these parameters.
- t<sub>r</sub> = ≤ 3 ns for the -12 and -15 speeds. t<sub>r</sub> = ≤ 5 ns for the -20 and slower speeds.

**Switching Characteristics Over the Operating Range<sup>[3,7]</sup>**

Parameter	Description	7C191-12 7C192-12		7C191-15 7C192-15		7C191-20 7C192-20		7C191-25 7C192-25		7C191-35 7C192-35		7C192-45		Unit
		Min.	Max.	Min.	Max.	Min.	Max.	Min.	Max.	Min.	Max.	Min.	Max.	
<b>READ CYCLE</b>														
t <sub>RC</sub>	Read Cycle Time	12		15		20		25		35		45		ns
t <sub>AA</sub>	Address to Data Valid		12		15		20		25		35		45	ns
t <sub>OHA</sub>	Output Hold from Address Change	3		3		3		3		3		3		ns
t <sub>ACE</sub>	CE LOW to Data Valid		12		15		20		25		35		45	ns
t <sub>LZCE</sub>	CE LOW to Low Z <sup>[8]</sup>	3		3		3		3		3		3		ns
t <sub>HZCE</sub>	CE HIGH to High Z <sup>[8,9]</sup>		5		7		9		11		15		15	ns
t <sub>PU</sub>	CE LOW to Power-Up	0		0		0		0		0		0		ns
t <sub>PD</sub>	CE HIGH to Power-Down		12		15		20		25		35		45	ns
<b>WRITE CYCLE<sup>[10]</sup></b>														
t <sub>WC</sub>	Write Cycle Time	12		15		20		25		35		45		ns
t <sub>SCE</sub>	CE LOW to Write End	9		10		15		18		22		22		ns
t <sub>AW</sub>	Address Set-Up to Write End	9		10		15		20		25		35		ns
t <sub>HA</sub>	Address Hold from Write End	0		0		0		0		0		0		ns
t <sub>SA</sub>	Address Set-Up to Write Start	0		0		0		0		0		0		ns
t <sub>PWE</sub>	WE Pulse Width	8		9		15		18		22		22		ns
t <sub>SD</sub>	Data Set-Up to Write End	8		9		10		10		15		15		ns
t <sub>HD</sub>	Data Hold from Write End	0		0		0		0		0		0		ns
t <sub>LZWE</sub>	WE HIGH to Low Z (7C192) <sup>[8]</sup>	3		3		3		3		3		3		ns
t <sub>HZWE</sub>	WE LOW to High Z (7C192) <sup>[8,9]</sup>		7		7		10		11		15		15	ns
t <sub>DWE</sub>	WE LOW to Data Valid (7C191)		12		15		20		25		30		35	ns
t <sub>ADV</sub>	Data Valid to Output Valid (7C191)		12		15		20		20		30		35	ns
t <sub>DCE</sub>	CE LOW to Data Valid (7C191)		12		15		20		25		35		45	ns

Shaded area contains preliminary information.

**Notes:**

- Test conditions assume signal transition time of 3 ns or less for -12 and -15 speeds and 5 ns or less for -20 through -45 speeds, timing reference levels of 1.5V, input pulse levels of 0 to 3.0V, and output loading of the specified I<sub>OL</sub>/I<sub>OH</sub> and 30-pF load capacitance.
- At any given temperature and voltage condition, t<sub>HZCE</sub> is less than t<sub>LZCE</sub>, t<sub>HZWE</sub> is less than t<sub>LZWE</sub> for any given device. These parameters are guaranteed by design and not 100% tested.
- t<sub>HZCE</sub> and t<sub>HZWE</sub> are specified with C<sub>L</sub> = 5 pF as in part (b) of AC Test Loads. Transition is measured ±500 mV from steady-state voltage.
- The internal write time of the memory is defined by the overlap of CE LOW and WE LOW. Both signals must be LOW to initiate a write and either signal can terminate a write by going HIGH. The data input set-up and hold timing should be referenced to the rising edge of the signal that terminates the write.

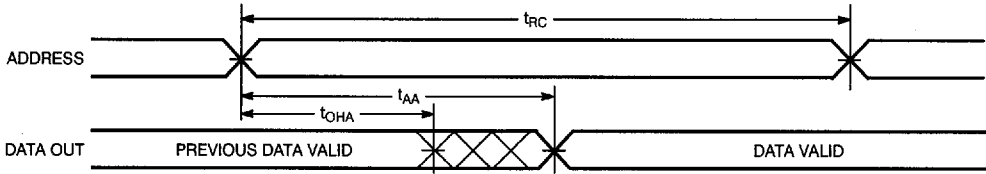
**Switching Waveforms**
**Read Cycle No. 1** [11, 12]

C191-6

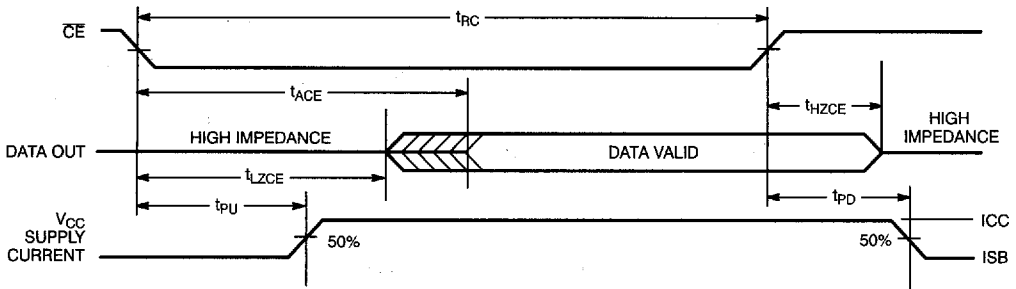
**Read Cycle No. 2** [11, 13]

C191-7

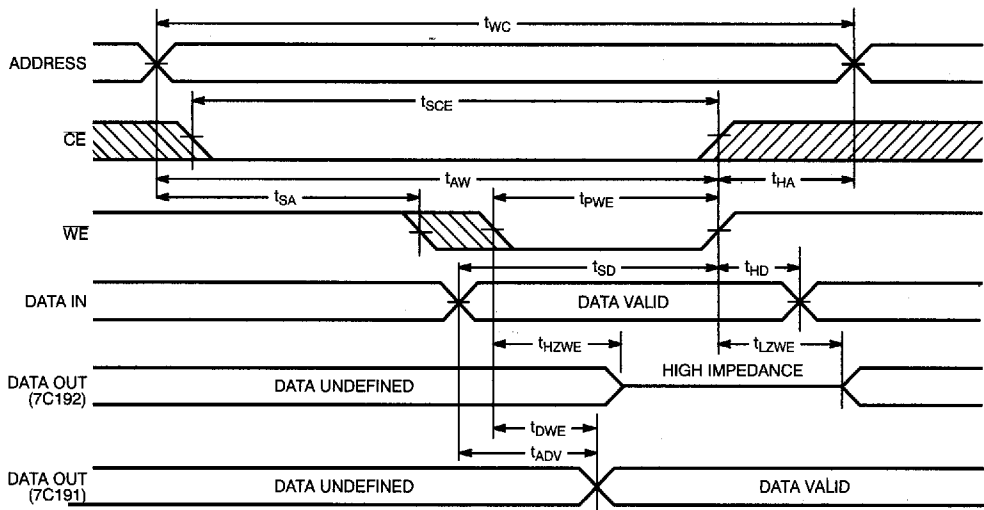
**Write Cycle No. 1 (WE Controlled)** [10]

C191-8

**Notes:**

11. WE is HIGH for read cycle.
12. Device is continuously selected,  $\overline{CE} = V_{IL}$ .
13. Address valid prior to or coincident with  $\overline{CE}$  transition LOW.
14. If  $\overline{CE}$  goes HIGH simultaneously with WE HIGH, the output remains in a high-impedance state (7C192 only).

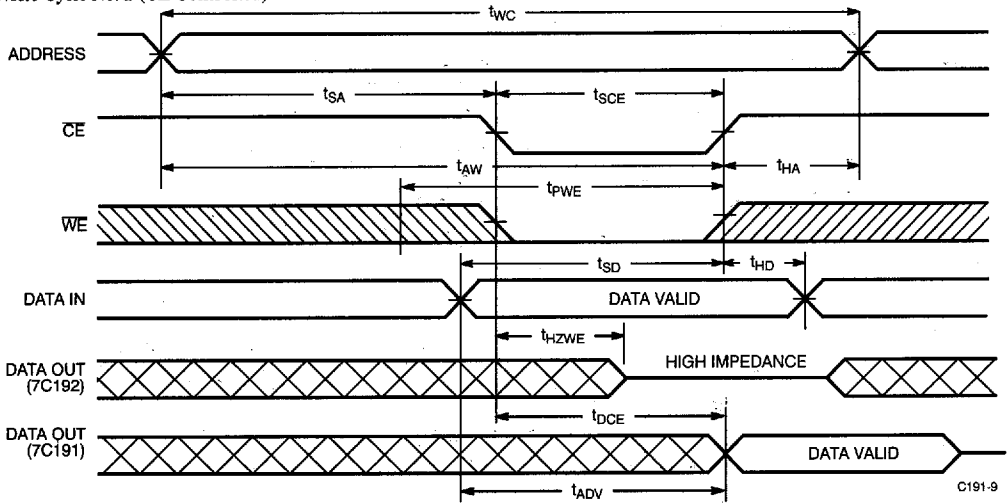
**Switching Waveforms (continued)**
**Write Cycle No. 2 ( $\overline{CE}$  Controlled)<sup>[10, 14]</sup>**

C191-9

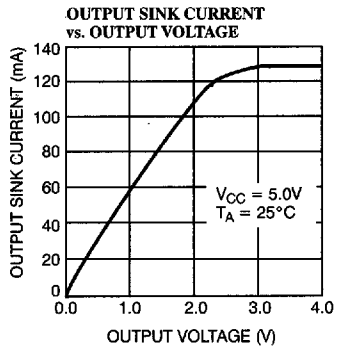
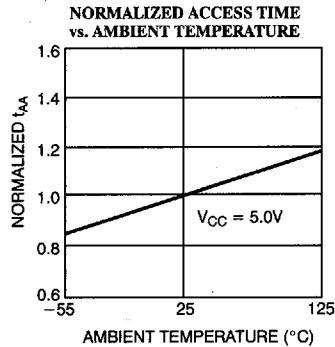
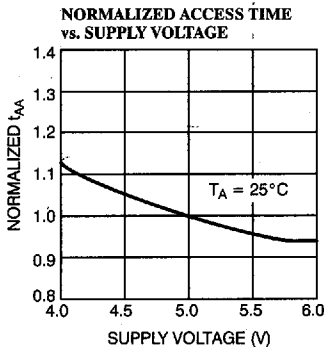
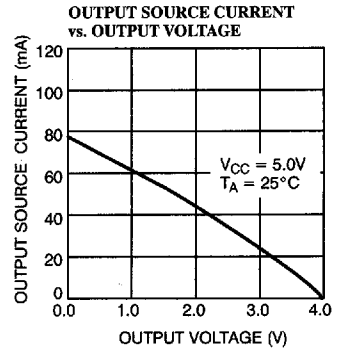
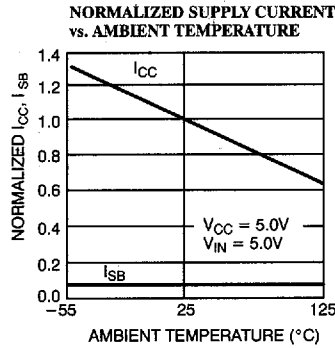
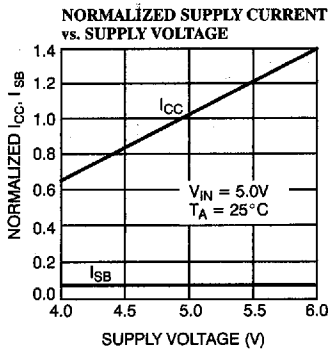
**Typical DC and AC Characteristics**

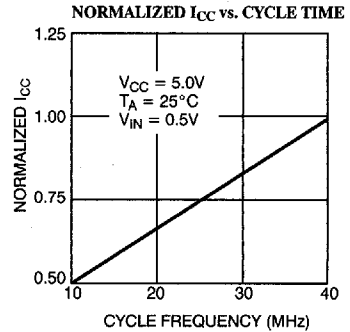
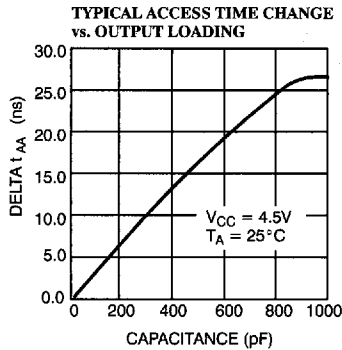
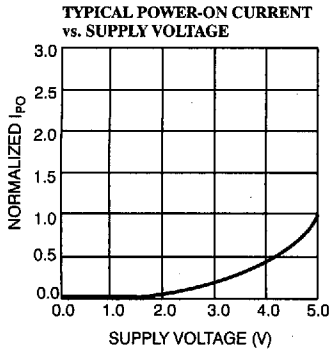
**Typical DC and AC Characteristics (continued)**

**Ordering Information**

Speed (ns)	Ordering Code	Package Name	Package Type	Operating Range
12	CY7C191-12PC	P21	28-Lead (300-Mil) Molded DIP	Commercial
	CY7C191-12VC	V21	28-Lead Molded SOJ	
15	CY7C191-15PC	P21	28-Lead (300-Mil) Molded DIP	Commercial
	CY7C191-15VC	V21	28-Lead Molded SOJ	
20	CY7C191-20PC	P21	28-Lead (300-Mil) Molded DIP	Commercial
25	CY7C191-25PC	P21	28-Lead (300-Mil) Molded DIP	Commercial
35	CY7C191-35PC	P21	28-Lead (300-Mil) Molded DIP	Commercial

Shaded area contains preliminary information.

**Ordering Information (continued)**

Speed (ns)	Ordering Code	Package Name	Package Type	Operating Range
12	CY7C192-12PC	P21	28-Lead (300-Mil) Molded DIP	Commercial
	CY7C192-12VC	V21	28-Lead Molded SOJ	
15	CY7C192-15PC	P21	28-Lead (300-Mil) Molded DIP	Commercial
	CY7C192-15VC	V21	28-Lead Molded SOJ	
	CY7C192-15DMB	D22	28-Lead (300-Mil) CerDIP	Military
20	CY7C192-20PC	P21	28-Lead (300-Mil) Molded DIP	Commercial
	CY7C192-20VC	V21	28-Lead Molded SOJ	
	CY7C192-20DMB	D22	28-Lead (300-Mil) CerDIP	Military
25	CY7C192-25PC	P21	28-Lead (300-Mil) Molded DIP	Commercial
	CY7C192-25VC	V21	28-Lead Molded SOJ	
	CY7C192-25DMB	D22	28-Lead (300-Mil) CerDIP	Military
	CY7C192-25LMB	L54	28-Pin Rectangular Leadless Chip Carrier	
35	CY7C192-35PC	P21	28-Lead (300-Mil) Molded DIP	Commercial
	CY7C192-35VC	V21	28-Lead Molded SOJ	
	CY7C192-35DMB	D22	28-Lead (300-Mil) CerDIP	Military
	CY7C192-35LMB	L54	28-Pin Rectangular Leadless Chip Carrier	
45	CY7C192-45DMB	D22	28-Lead (300-Mil) CerDIP	Military
	CY7C192-45LMB	L54	28-Pin Rectangular Leadless Chip Carrier	

Shaded area contains preliminary information.

**MILITARY SPECIFICATIONS**
**Group A Subgroup Testing**
**DC Characteristics**

Parameter	Subgroups
V <sub>OH</sub>	1, 2, 3
V <sub>OL</sub>	1, 2, 3
V <sub>IH</sub>	1, 2, 3
V <sub>IL</sub> Max.	1, 2, 3
I <sub>IX</sub>	1, 2, 3
I <sub>OZ</sub>	1, 2, 3
I <sub>CC</sub>	1, 2, 3
I <sub>SB1</sub>	1, 2, 3
I <sub>SB2</sub>	1, 2, 3

Document #: 38-00076-J

**Switching Characteristics**

Parameter	Subgroups
<b>READ CYCLE</b>	
t <sub>RC</sub>	7, 8, 9, 10, 11
t <sub>AA</sub>	7, 8, 9, 10, 11
t <sub>OHA</sub>	7, 8, 9, 10, 11
t <sub>ACE</sub>	7, 8, 9, 10, 11
<b>WRITE CYCLE</b>	
t <sub>WC</sub>	7, 8, 9, 10, 11
t <sub>SCE</sub>	7, 8, 9, 10, 11
t <sub>AW</sub>	7, 8, 9, 10, 11
t <sub>HA</sub>	7, 8, 9, 10, 11
t <sub>SA</sub>	7, 8, 9, 10, 11
t <sub>PWE</sub>	7, 8, 9, 10, 11
t <sub>SD</sub>	7, 8, 9, 10, 11
t <sub>HD</sub>	7, 8, 9, 10, 11
t <sub>AWE</sub> <sup>[15]</sup>	7, 8, 9, 10, 11
t <sub>ADV</sub> <sup>[15]</sup>	7, 8, 9, 10, 11

 Note:  
 15. CY7C191 only